

**CASCADE ZONING BOARD OF ADJUSTMENT MEETING
PUBLIC NOTICE & AGENDA
WEDNESDAY, AUGUST 2, 2023**

6:00 P.M.

COUNCIL CHAMBERS, 320 1ST AVE WEST

NOTICE: Notice is hereby given that the Cascade Zoning Board of Adjustment will hold a meeting on **Wednesday, August 2, 2023 at 6:00 PM** in the Cascade City Hall Council Chambers, 320 1st Ave W, Cascade, IA 52033. Any visual or hearing- impaired persons or persons with special accessibility needs should contact the City Clerk at 563-852-3114 prior to the meeting.

1. Call to Order.
2. Roll Call.
3. Approve the Agenda
4. Meeting Minutes - Review & approve the May 4, 2023 meeting minutes.
4. Public Hearing-Hold a public hearing on a request from Rob McNally for a Special Exception in R-1 Single Family District to install roof mounted solar panels at 601 1st Ave East
5. Consideration of a Special Exception to Install Solar Panels on an R-1 Single Family Property located at 601 1st Ave East
7. Adjournment.

Zoning Board of Adjustment Minutes
May 4, 2023

The May 4, 2023 Zoning Board of Adjustment meeting was called to order at 6:00 p.m. at the Cascade City Hall by Chairperson Hoffmann. Board members present were Linda Hoffmann, Merlin McDermott, Suzanne Otting, and Ross Orr. Excused: Clay Gavin

Others Present: Lisa Kotter and Mark Otting

Motion McDermott, second Otting to approve the agenda as presented – all ayes.

Motion Orr, second by McDermott to open the public hearing for the Aquin Day Care extra lot at 3rd Ave NW at 6:02pm – all ayes.

Kotter and guest Mark Otting explained the project planned to use the second lot owned by Little Angels as an extension of the daycare’s backyard. There will be a requirement to follow the vision triangle rule at the corner for the fence. The proposed fence is 4feet tall and chain link.

Motion Otting, second McDermott to close the public hearing. All ayes.

Motion McDermott, second Orr to approve a special exception for the Aquin Day Care Little Angels at 401 3rd Avenue NW to be used for the purposes of a day care facility in Single Family R1 zoning.

Motion by McDermott, 2nd by Otting to adjourn the meeting at 6:06 p.m. – all ayes.

Respectfully submitted,

Lisa A. Kotter
City Administrator

Board of Adjustment Hearing Application
City of Cascade

Hearing No.: _____

Hearing Fee: _____

1. Name and address of applicant: Eagle Point Solar

2400 Kerper Blvd. Suite A20

'Dubuque, IA 52001 563-582-4044

(Phone Number)

2. Nature of the Request: _____ Interpretation and review of decision of zoning administrator.
(Check which applies) (Complete Section I of Application)

Special Use or Exception Permit as required by the Zoning Ordinance. (For Solar Energy Systems)
(Complete Section II of Application)

_____ Variance to a requirement of the Zoning Ordinance.
(Complete Section III of Application)

3. Location and dimensions of property: 601 1st Ave E., Cascade, IA 52033
(Street Address)

1st array 12'8" x 17'4" 2nd array 12'8" x 10'5" total sq ft = 714'24"
(Width, Depth, and Area in sq. ft.)

4. Legal description of property: Lot 94 Railroad Add (county)
(Lot Number (s), Block Number (s), Subdivision Name)

5. Present zoning classification: R- Residential
(Example A-1, R-1, C-2, M-1)

6. Existing and Proposed Uses of the Property: Installation of roof mounted solar arrays

7. Attach a plat showing the location, dimensions, and use of the property and all property within 200 feet thereof including streets, alleys, and other prominent physical features.

6. Attach the names and addresses of all property owners within 200 feet of property to be re-zoned.

7. Signature and date: Mary Jo Pullen - Eagle Point Solar 7-6-2023
(Applicants or Property Owners Signature) (Date)

8. Application Fee \$200.

SECTION II

REQUEST FOR SPECIAL EXCEPTION as required by Section _____ of the Cascade Zoning Ordinance.

1. What is the proposed Special Exception (attached plat plan)? To obtain a building permit

to install solar.

2. How will the proposed Special Exception be compatible with adjacent properties and other properties in the zoning classification district?

No impact on adjacent properties, since this project is roof mounted.

3. The Special Exception will not be detrimental to the character of the neighborhood because:

Many people would view this project to enhance the value of the property



A Place We Call Home

City of Cascade
320 1st Avenue West
P.O. Box 400
Cascade, Iowa 52033
Ph. 563-852-3114
admin@citycascade.com

NOTICE OF SPECIAL EXCEPTION HEARING

You are being notified of a Public Hearing for a Special Exception for a Solar System on
A Roof at 601 1st Ave East in Cascade.

Zoning Board of Adjustment
Wednesday, August 2, 2023, 6:00 p.m.
Cascade City Hall
320 1st Avenue West

Special Exception for Solar Energy System
Applicant: Robert McNally, 601 1st Ave East

Notice is hereby given that a meeting is set for Wednesday, August 2, 2023 at 6:00 p.m. at which time the Cascade Board of Adjustment will hold a public hearing at the Cascade City Hall, 320 1st Avenue West. The request from Rob McNally is for a special exception in an R-1 Single Residential District to install a Solar Energy System on the roof. The application is available for review at City Hall. At the above listed time and place, the public will be given the opportunity to comment on this request. Written opinions on the application can be made at City Hall or by email at admin@citycascade.com. You are receiving this notification as you are within 200 feet of 601 1st Ave East.

Sincerely,

Lisa A. Kotter
City Administrator

SHOP LOCAL, BUY LOCAL

Aitchison
PO Box 307
Cascade, IA 52033

Conter
109 N Van Buren St NE
Cascade, IA 52033

Coohy
105 Van Buren St NE
Cascade, IA 52033

Unity Point
350 N Grandview Ave
Dubuque, IA 52001

Finzel
108 Harrison St NE
Cascade, IA 52033

Geraghty
105 Harrison St NE
Cascade, IA 52033

Grill
618 1st Ave E
Cascade, IA 52033

Gudenkauf
PO Box 609
Cascade, IA 52033

Hoffmann
108 Van Buren St NE
Cascade, IA 52033

Knepper
505 1st Ave E
Cascade, IA 52033

McDermott
PO Box 355
Cascade, IA 52033

Menge
515 1st Ave E
Cascade, IA 52033

Redmond
24380 7th Ave
Bernard, IA 52032

Ries
614 1st Ave E
Cascade, IA 52033

Takes
107 Jackson St NE
Cascade, IA 52033

Wagner
610 1st Ave E
Cascade, IA 52033

Cascade Elementary
PO Box 68
Farley, IA 52046

Sheet Index	
Page #	Description
1	Cover Page
2	BOM
3	Utility Plot Plan
4	Installation/BP Plot Plan
5	Equipment Plan
6	Stringing/Racking
7	One Line
8	Placards/Labels

McNally, Robert

601 1st Ave E, Cascade, IA 52033
 Robert McNally - (563) 495-0558



Eagle Point Solar
 2400 Kerper Blvd
 Ste A-20
 Dubuque, Iowa 52001
 563-582-4044

PROJECT
McNally, Robert

CLIENT / SITE
 Robert McNally
 601 1st Ave E,
 Cascade, IA 52033
 (563) 495-0558

Solar Energy Consultant
 Cory Wernimont
 563-552-9576

DATE	DESCRIPTION	REV
	Per plan and one line done	1
		2
		3
		4
		5

SHEET TITLE
COVER PAGE
 Drawn By



Photovoltaic
 Kyle Silva
 PVA-061521-037755

Designer

 Kyle Silva
 Senior Solar Design
 Specialist

Site Assessor
 Rory Mulgrew

Utility
 Cascade Municipal Utility

EDITION DATE
 April 3, 2023

01 REVISION
 1



Project Name: **McNally, Robert**

Location: **601 1st Ave E, Cascade, IA 52033**



Eagle Point Solar
2400 Kerper Blvd
Ste A-20
Dubuque, Iowa 52001
563-582-4044

Location	Material	Manufacturer	Model	Qty Needed	Qty Recommended	Van Meter SKU	Review Qty
Site	Modules	VSUN	VSUN400-132BMH	15	15	.10062926	
Site	Racking - Roof	IronRidge XR100 - Black	XR100 11' rail - Black	4	4	.7418495	
Site	Racking - Roof	IronRidge XR100 - Black	XR100 254" (21.17') rail - Black	4	4	.10018660	
Shop	Microinverters	Hoymiles	HM-300NT, Bus Cable	1	1	.7846432	
Shop	Microinverters	Hoymiles	HM-600NT, Bus Cable	7	7	.7846434	
Shop	Microinverters	Hoymiles Accessories	2.3M Bus Cable	8	8	.10086790	
Shop	Microinverters	Hoymiles Accessories	T Connector End Cap (End of Connector Cap)	1	1	.7846445	
Shop	Racking - Roof	IronRidge XR100 - Black	UFO - Universal Module Clamp - Black - 4 piece kit	38	40	.7715238	
Shop	Racking - Roof	IronRidge XR100 - Black	UFO Stopper Sleeve TOTAL, 35mm - Black - 4 piece kit	16	18	.7753901	
Shop	Racking - Roof	IronRidge Accessories	XR100 Rail End Caps - 10 sets per pag: 1 set = 1L, 1R	8	10	.7418503	
Shop	Racking - Roof	IronRidge Accessories	1/4" x 3/4" Microinverter Bonding Hardware T-Bolt - 2 Piece Kit	16	18	.7703542	
Shop	Racking - Roof	IronRidge Accessories	Square Bolt Bonding Attachment Hardware	30	32	.7715247	
Shop	Racking - Roof	IronRidge Accessories	Grounding Lug, Low Profile - 2 piece kit	4	4	.7706512	
Shop	Racking - Roof	SolaDeck	SOLADECK 0799-5B	2	2	.7726240	
Shop	Racking - Roof	PLP	Easy Feet	30	32	.7787049	
Shop	Communications	Hoymiles Accessories	DTU PRO Wireless Communication	1	1	.7821361	
Non-VM Material	DC Connectors	SunRunner	SunRunner 2-S Clip/Bulk, Model 18-56488	60	60		
Non-VM Material	DC Connectors	Staubli	MC4 PV Connector Male (600V)	14	15	.7204575	
Non-VM Material	DC Connectors	Staubli	MC4 PV Connector Female (600V)	14	15	.7204567	
Non-VM Material	EPS Yard Sign	EPS Yard Sign	EPS Yard Sign	1	1		
Non-VM Material	Communications	EPS Comm Packages	CAT5 5' Cable (DTU Pro)	1	1	.541622	
Equipment	Recommended		Lift w/ Basket	1	1		

PROJECT
McNally, Robert

CLIENT / SITE
Robert McNally
601 1st Ave E,
Cascade, IA 52033
(563) 495-0558

Solar Energy Consultant
Cory Wernimont
563-552-9576

DATE	DESCRIPTION	REV
	Not plan into one line code	

SHEET TITLE
Bill of Materials
Drawn By



Photovoltaic
Kyle Silva
PVA-061521-037755

Designer
Kyle Silva
Senior Solar Design
Specialist

Site Assessor
Rory Mulgrew

Utility
Cascade Municipal Utility

EDITION DATE
April 3, 2023

02 REVISION
1

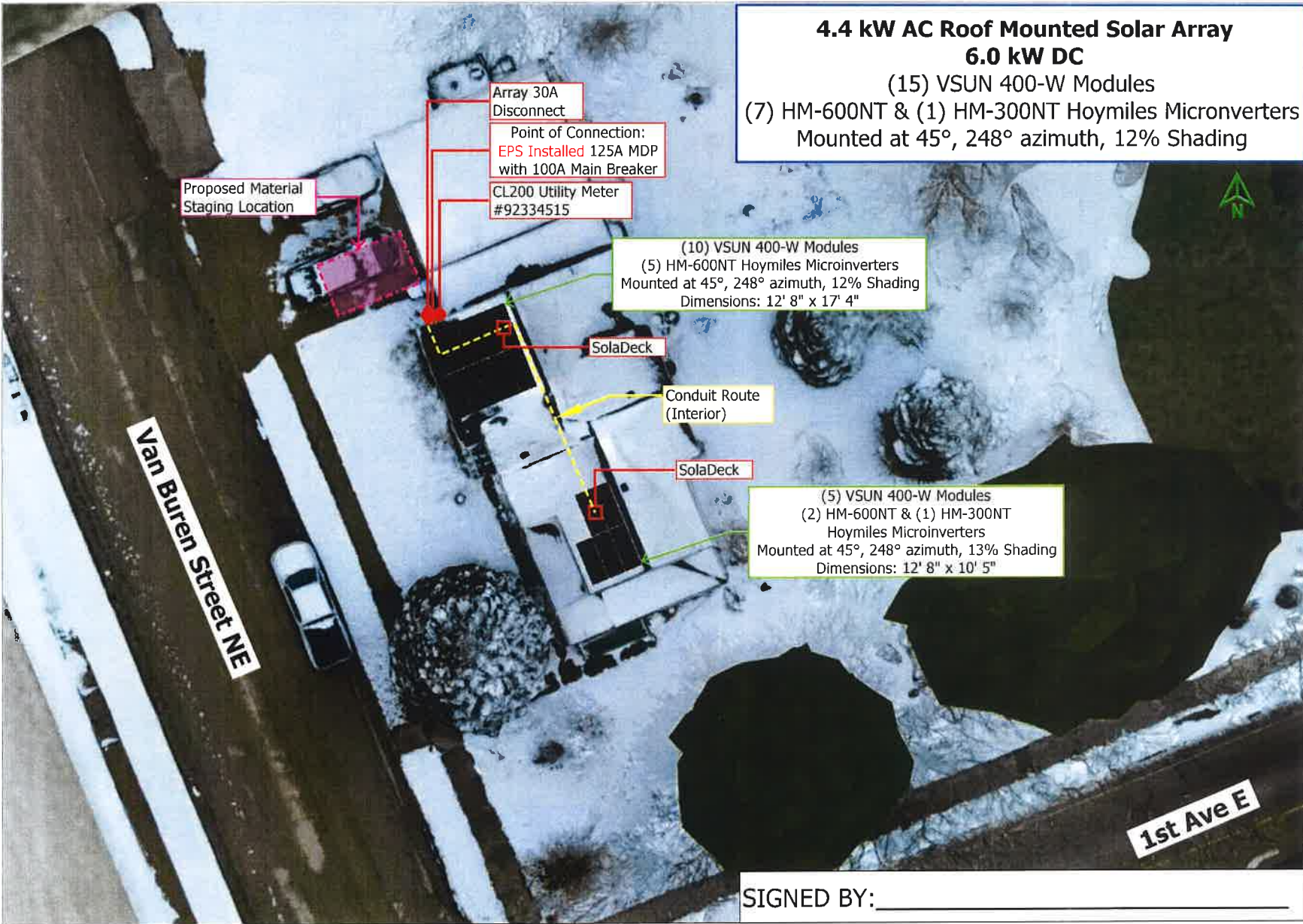

4.4 kW AC Roof Mounted Solar Array
6.0 kW DC
 (15) VSUN 400-W Modules
 (7) HM-600NT & (1) HM-300NT Hoymiles Microinverters
 Mounted at 45°, 248° azimuth, 12% Shading

Eagle Point SOLAR
Eagle Point Solar
 2400 Kerper Blvd
 Ste A-20
 Dubuque, Iowa 52001
 563-582-4044

PROJECT
McNally, Robert

CLIENT / SITE
 Robert McNally
 601 1st Ave E,
 Cascade, IA 52033
 (563) 495-0558

Solar Energy Consultant
 Cory Wernimont
 563-552-9576

DATE	DESCRIPTION	REV	BY	CHK	APP
	Plot Plan and Site Line Copy				

SHEET TITLE
Plot Plan
 Drawn By

NABCEP ASSOCIATE
 Photovoltaic
 Kyle Silva
 PVA-061521-037755

Designer
 Kyle Silva
 Senior Solar Design Specialist

Site Assessor
 Rory Mulgrew
Utility
 Cascade Municipal Utility
EDITION DATE
 April 3, 2023

SIGNED BY: _____

03 REVISION
 1

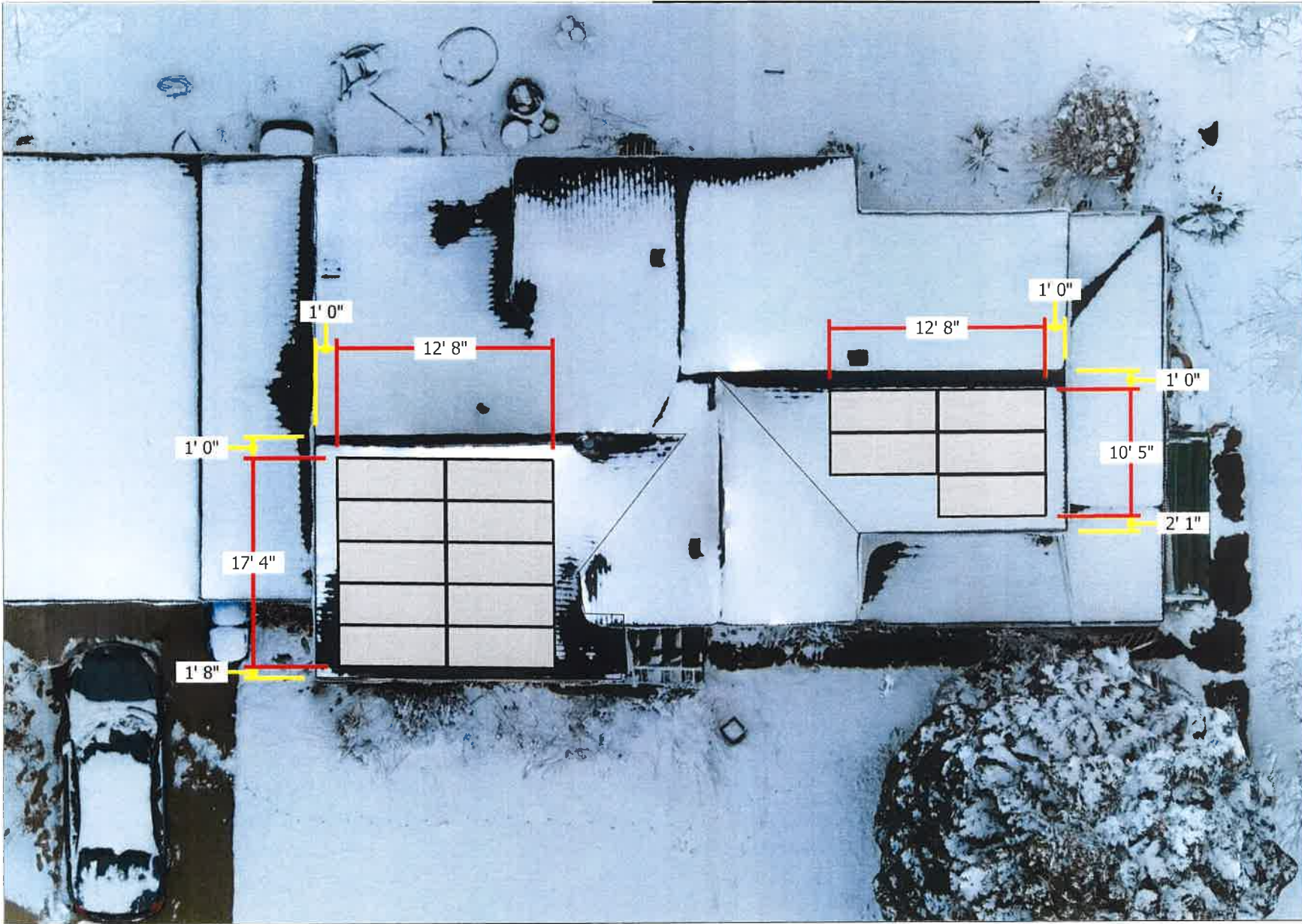

Eagle Point Solar
 2400 Kerper Blvd
 Ste A-20
 Dubuque, Iowa 52001
 563-582-4044

PROJECT
McNally, Robert

CLIENT / SITE
 Robert McNally
 601 1st Ave E,
 Cascade, IA 52033
 (563) 495-0558

Solar Energy Consultant
 Cory Wernimont
 563-552-9576

DATE	DESCRIPTION	REV	BY	DATE
	Plot plan and one line cover			

SHEET TITLE
Install Plot Plan
 Drawn By



Photovoltaic
 Kyle Silva
 PVA-061521-037755

Designer

 Kyle Silva
 Senior Solar Design
 Specialist

Site Assessor
 Rory Mulgrew

Utility
 Cascade Municipal Utility

EDITION DATE
 April 3, 2023

04 REVISION
 1



Eagle Point SOLAR

Eagle Point Solar
 2400 Kerper Blvd
 Ste A-20
 Dubuque, Iowa 52001
 563-582-4044

PROJECT
McNally, Robert

CLIENT / SITE
 Robert McNally
 601 1st Ave E,
 Cascade, IA 52033
 (563) 495-0558

Solar Energy Consultant
 Cory Wernimont
 563-552-9576

DATE	DESCRIPTION	REV	BY	DATE
	Per plan and see loc cover			

SHEET TITLE
Equipment Plan
 Drawn By

ASSOCIATE

Photovoltaic
 Kyle Silva
 PVA-061521-037755
 Designer

Kyle Silva
 Senior Solar Design
 Specialist

Site Assessor
 Rory Mulgrew
 Utility
 Cascade Municipal Utility
EDITION DATE
 April 3, 2023

SIGNED BY: _____

05 **REVISION**
 1

Roof Array			Layout Design Specs	Max Span (Feet)		VSUN 400'S			Micro Branching				
KEY	11' Rail			Max Cantilever (Feet)	3'	Module Dimensions	Length (Inches)	75.91" or 75 - 15/16"	Branch SolaDeck		KEY	1 to 1 Micros	
	14' Rail			Module Clamping Range	9.48" - 18.98"		Width (Inches)	41.26" or 41- 1/4"	2 to 1 Micros			3 to 1 Micros	
	14.25' Rail			Calculated Span for BOM	4'		Thickness (mm)	35 mm	4 to 1 Micros			Ex:	3 - 10
	17' Rail												
	17.67' Rail												
20' Rail													
21.17' Rail													
Splice													

Eagle Point SOLAR

Eagle Point Solar
 2400 Kerper Blvd
 Ste A-20
 Dubuque, Iowa 52001
 563-582-4044

PROJECT
McNally, Robert

CLIENT / SITE
 Robert McNally
 601 1st Ave E,
 Cascade, IA 52033
 (563) 495-0558

Solar Energy Consultant
 Cory Wernimont
 563-552-9576

DATE	DESCRIPTION	REV
	Rev (plan and spec files done)	

SHEET TITLE
Stringing/Racking
 Drawn By

NABCEP ASSOCIATE

Photovoltaic
 Kyle Silva
 PVA-061521-017755

Designer

Kyle Silva
 Senior Solar Design Specialist

Site Assessor
 Rory Mulgrew

Utility
 Cascade Municipal Utility

EDITION DATE
 April 3, 2023

06	REVISION 1
-----------	----------------------

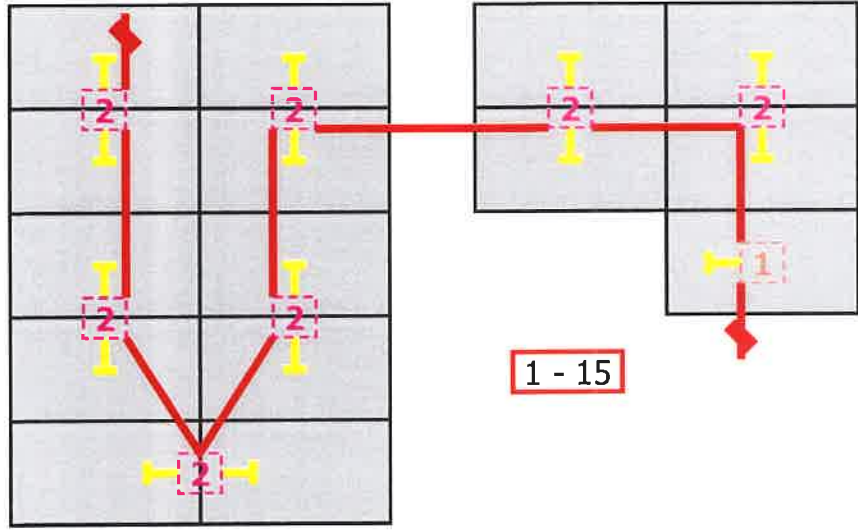
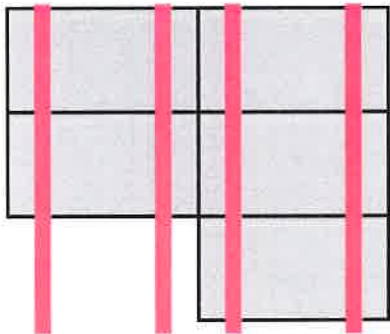
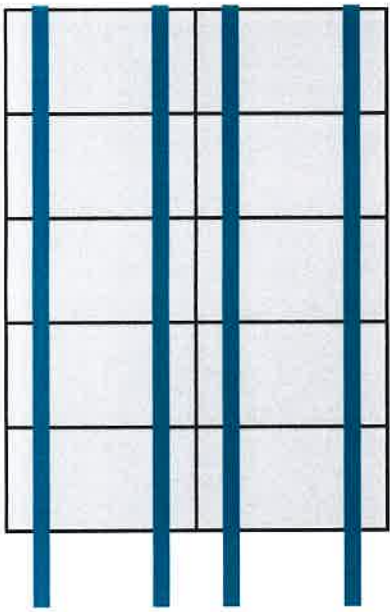

	Proposed Equipment/Components
	Existing Equipment
	Conduit/Wire

Alliant Energy IA Interconnection Questions:

1. Are there multiple meters on site? If so, how many?
No
2. What is the existing electric service capacity (service entrance in Ampe)?
200A
3. What is the type of Service Connection?
Inverter Existing
4. Will there be changes to the service entrance? If yes, provide description
No
5. Is the service being upgraded? If yes, what is the amperage?
No

Hoymiles HM-300NT Microinverter
96.5% Efficiency @ 240Vac
295VAc continuous
MAX Current 1.23A / micro

Hoymiles HM-600NT Microinverter
96.5% Efficiency @ 240Vac
590VAc continuous
MAX Current 2.46A / micro



RS485 Communication to Meter
Ethernet Port or WiFi option

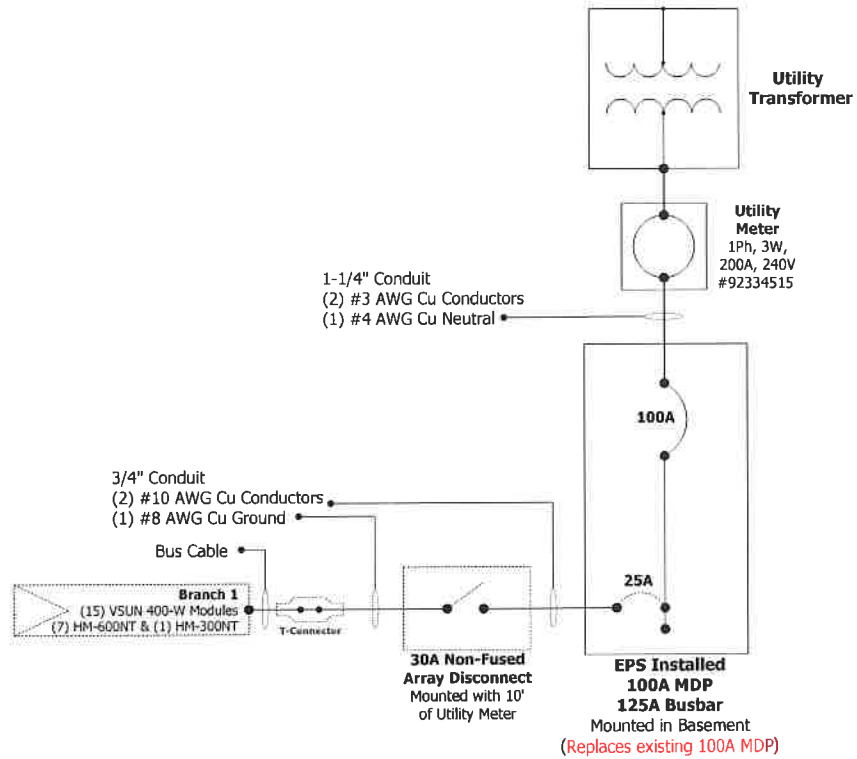

Eagle Point SOLAR
2400 Kerper Blvd
Ste A-20
Dubuque, Iowa 52001
563-582-4044

PROJECT
McNally, Robert

CLIENT / SITE
Robert McNally
601 1st Ave E,
Cascade, IA 52033
(563) 495-0558

Solar Energy Consultant
Cory Wernimont
563-552-9576

DATE	DESCRIPTION	REV
	Per plan and one line done	

SHEET TITLE
One Line
Drawn By

NABCEP ASSOCIATE
Photovoltaic
Kyle Silva
PVA-061521-037755

Designer
Kyle Silva
Senior Solar Design
Specialist

Site Assessor
Rory Mulgrew

Utility
Cascade Municipal Utility

EDITION DATE
April 3, 2023

07 REVISION 1

CAUTION

MULTIPLE POWER SOURCES
POWER TO THIS SERVICE IS ALSO SUPPLIED
FROM THE FOLLOWING PV SOURCE
WITH DISCONNECT LOCATED AS SHOWN

2020 NEC 705.10 - Site Map Placard SAMPLE: Located at Meter & Inverter

Dual Power Source Photovoltaic
Operating Voltage: 240V
Maximum Current: 32A
Maximum Power: 7.6kW AC

2020 NEC 690.53 - Placard SAMPLE: Located at Meter

RAPID SHUTDOWN REQUIREMENTS MET

INTERCONNECTION DISCONNECT SWITCH

2020 NEC 690.56 - Placard: Located at AC Disconnect

PHOTOVOLTAIC SYSTEM

AC DISCONNECT

Operating Voltage: VOLTS
Maximum Current: AMPS

2020 NEC 690.54 - Sticker: Located at AC Disconnect/Main/Sub Panel

PHOTOVOLTAIC

DC DISCONNECT

Sticker: Located at DC Disconnect (If Applicable)

RAPID SHUTDOWN SWITCH FOR SOLAR PV SYSTEM

NEC 2020 690.56(C)(2) - Sticker: Located at AC Disconnect

WARNING

TURN OFF PHOTOVOLTAIC AC DISCONNECT PRIOR TO WORKING INSIDE PANEL

Sticker: Located at AC Disconnect & Main/Sub Panel

SOLAR PV SYSTEM EQUIPPED WITH RAPID SHUTDOWN

TURN RAPID SHUTDOWN SWITCH TO THE "OFF" POSITION TO SHUT DOWN PV SYSTEM AND REDUCE SHOCK HAZARD IN THE ARRAY

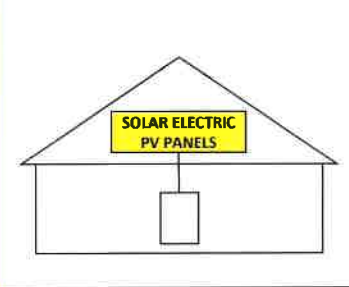

2020 NEC 690.56(C)(1) - Sticker: Located at Inverter

CAUTION

SOLAR ELECTRIC SYSTEM CONNECTED

Sticker: Located at Meter & Main/Sub Panel

WARNING: PHOTOVOLTAIC POWER SOURCE

2012 NFPA 11.12.2.1.1, 2020 NEC 690.31(B)(1) - Sticker: Located at All DC Raceways (every 10')

MAIN SOLAR SYSTEM AC DISCONNECT

2020 NEC 690.13(B) - Sticker: Located at Main AC Disconnect

DO NOT DISCONNECT UNDER LOAD

Sticker: Located at Meter & Main Distribution Panel

WARNING

ELECTRICAL SHOCK HAZARD

DO NOT TOUCH TERMINALS

TERMINALS ON BOTH LINE AND LOAD SIDES MAY BE ENERGIZED IN THE OPEN POSITION

DC VOLTAGE IS ALWAYS PRESENT WHEN SOLAR MODULES ARE EXPOSED TO SUNLIGHT

2020 NEC 690.13(B) - Sticker: Located at Junction Box/Combiner/Disconnect

WARNING

INVERTER OUTPUT CONNECTION

DO NOT RELOCATE THIS OVERCURRENT DEVICE

2020 NEC 705.12(B)(2)(3)(b) - Sticker: Located at Main/Sub Panel

WARNING

DUAL POWER SOURCE

SECOND SOURCE IS PHOTOVOLTAIC SYSTEM

Sticker: Located at Meter/AC Disc Main/Sub Panel



Eagle Point Solar
2400 Kerper Blvd
Ste A-20
Dubuque, Iowa 52001
563-582-4044

PROJECT
McNally, Robert

CLIENT / SITE
Robert McNally
601 1st Ave E,
Cascade, IA 52033
(563) 495-0558

Solar Energy Consultant
Cory Wernimont
563-552-9576

DATE	DESCRIPTION	REV
	Per plan and on-line done	

SHEET TITLE
Placards / Labels
Drawn By



Photovoltaic
Kyle Silva
PVA-061521-037755
Designer

Kyle Silva
Senior Solar Design Specialist

Site Assessor
Rory Mulgrew
Utility
Cascade Municipal Utility
EDITION DATE
April 3, 2023

08 REVISION
1